

AKAI
professional

SG01_p

PIANO SOUND MODULE

WARNING

To prevent fire or shock hazard, do not expose this appliance to rain or moisture.

Operator's Manual

WARNING

The SG01p is designed to be used in a standard household environment. Power requirements for electrical equipment vary from area to area. Please ensure that your AC Adaptor supplied meets the power requirements in your area. If in doubt, consult a qualified electrician or Akai Professional dealer.

120 VAC	@ 60 Hz for USA and Canada
220~230/240 VAC	@ 50 Hz for Europe
240 VAC	@ 50 Hz for Australia

PROTECTING YOURSELF AND THE SG01p

- Never touch the AC Adaptor with wet hands.
- Always disconnect the AC Adaptor from the power supply by pulling on the adaptor/plug, not the cord.
- Allow only an Akai Professional dealer or qualified professional engineer to repair or reassemble the SG01p. Apart from voiding the warranty, unauthorized engineers might touch live internal parts and receive a serious electrical shock.
- Do not put, or allow anyone to put any object, especially metal objects, into the SG01p.
- Use only a household AC power supply. Never use a DC power supply.
- If water or any other liquid is spilled into or onto the SG01p, disconnect the power, and call your dealer.
- Make sure that the unit is well-ventilated, and away from direct sunlight.
- To avoid damage to internal circuitry, as well as the external finish, keep the SG01p away from sources of direct heat (stoves, radiators, etc.).
- Avoid using aerosol insecticides, etc. near the SG01p. They may damage the surface, and may ignite.
- Do not use denaturated alcohol, thinner or similar chemicals to clean the SG01p. They will damage the finish.
- Modification of this equipment is dangerous, and can result in the functions of the SG01p being impaired. Never attempt to modify the equipment in any way.
- Make sure that the SG01p is always well-supported when in use on a firm level surface.
- In order to assure optimum performance of your SG01p, select the setup location carefully, and make sure the equipment is used properly. Avoid setting up the SG01p in the following locations:
 1. In a humid or dusty environment
 2. In a room with poor ventilation
 3. On a surface which is not horizontal
 4. Inside a vehicle such as a car, where it will be subject to vibration
 5. In an extremely hot or cold environment

Table of Contents

Introduction	1
Features	1
 Panel Descriptions	 2
Front Panel	2
Rear Panel	3
 Connections	 4
MIDI Connections	5
■ Connecting to a MIDI Controller	5
■ Using a MIDI Interface Unit	5
■ Connecting to a GM Sound Module	6
 Playing	 7
Demo Mode	7
■ Preset Tune List	7
Single Mode	8
Multi Mode	10
■ Program Changes from the Sequencer	11
 Setups	 12
Switching to Single/Multi Mode	12
Selecting a MIDI Channel	13
Selecting a Program	13
Editing a Program	14
◆ Key Parameter Editing System	14
■ SHAPE—Adjusting a Sound Envelope	14
■ TONE—Adjusting a Sound Tonal Quality	15
■ SPECIAL—Adding a Characteristic Tone	15
■ LEVEL—Adjusting a Sound Relative Level	16
■ FX LEVEL—Adjusting a Reverb Send Level	16
■ Resetting a Program	17
■ Saving Parameter Settings onto an External MIDI Device	18
Tuning	19

Appendix	20
Program List	20
■ Tonal Effects	20
Reverb List	21
MIDI Messages	22
SG01p MIDI Implementation Chart	26
Specifications	27

Introduction

Thank you for buying an AKAI SG01p Piano Synthesizer Sound Module.

The instrument incorporates various acoustic keyboards sounds like conventional piano, its variations, electric piano, clavinet, etc., which have been produced using a highly acclaimed sampling technology from AKAI S-series samplers. The half-rack sized module is, as a single channel sound module or 16-channel multi-timbral sound module, fully controllable from an external MIDI controller.

To fully use the SG01p, please read this operator's manual thoroughly before operations. Also, keep this manual in an accessible location for future reference.

In addition, any panel controls or pots are represented in bold uppercase characters in this manual.

Features

- Sound module with 32 polyphonic voices (30 voices with a reverb effect in use)
- 50 realistic preset sounds including acoustic piano, electric piano, clavinet, etc.
- 16-channel multi-timbre feature
- Sounds editing available using parameters like **SHAPE**, **TONE**, **SPECIAL**, etc.
- 30 types of reverb effects with different effect send levels for 16 multi-timbral parts
- Bulk dump feature for storing the sound settings onto an external MIDI sequencer, etc.

Panel Descriptions

Front Panel

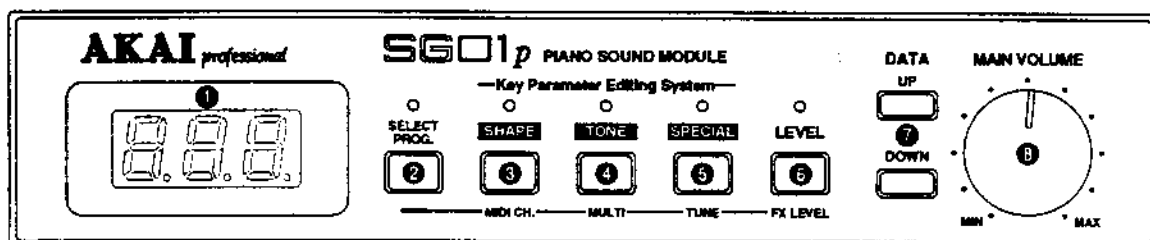

1 Display

This three digit 7-segment LED display shows a program number of current selection, and in editing, parameter values, etc.

2 SELECT PROG.

When selecting a program, press this key and turn on the LED; The LED is initially turned on when the module is turned on. To select a program, press DATA UP or DOWN while holding down this key. Also, pressing a parameter key along with this key selects that parameter.

3 SHAPE (MIDI CH.)

Pressing this key to turn on the LED shows the SHAPE parameters (on page 14) for the current sound in the display. Pressing this key along with SELECT PROG. provides the MIDI channel selection display.

4 TONE (MULTI)

Pressing this key to turn on the LED shows the TONE parameters (on page 15) for the current sound in the display. Pressing this key along with SELECT PROG. provides the Multi mode selection display.

5 SPECIAL (TUNE)

Pressing this key to turn on the LED shows the SPECIAL parameters (on page 15) for the current sound in the display. Pressing this key along with SELECT PROG. provides the global tuning display for the whole module.

6 LEVEL (FX LEVEL)

Pressing this key to turn on the LED provides the part level (on page 16) for the current sound in the display. Pressing this key along with SELECT PROG. provides the effect send level for the current sound in the display.

7 DATA UP, DOWN

Use these keys to change a current value (program number, parameter value, etc.) shown in the display. Pressing the key and holding it down will change the value continuously; the change of value will become faster in two seconds.

8 MAIN VOLUME

Use this to adjust a whole level at OUTPUT and PHONES on the module.

Rear Panel

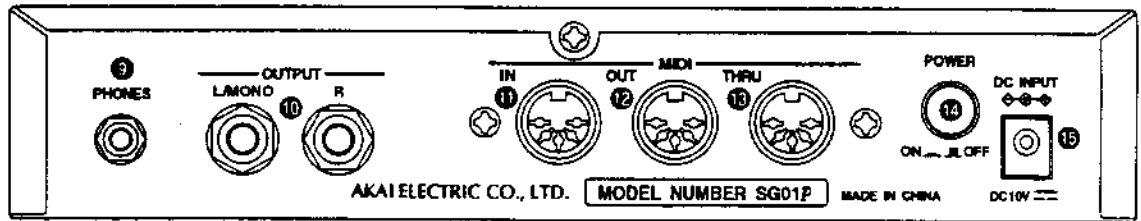

9 PHONES

Connect a pair of headphones here. Headphone volume is adjusted by **MAIN VOLUME**.

10 OUTPUT

Sends out the module's internal sounds. Total volume is adjusted by **MAIN VOLUME**. When a mono sound is needed, connect only to L/MONO.

11 MIDI IN

Connect with MIDI OUT on an external MIDI keyboard or sequencer using a MIDI cable.

12 MIDI OUT

Connect with MIDI IN on an external MIDI sequencer using a MIDI cable, to save sound parameter values as MIDI exclusive data.

13 MIDI THRU

Connect with MIDI IN on an external MIDI device to control together; The module outputs the data received at MIDI IN from here.

14 POWER

Turns the module on or off.

15 DC INPUT

Connect the supplied AC adapter here.

Playing

Demo Mode

The module comes with 7 preset tunes for demonstration. You do not need any MIDI controller or setup for auditioning sounds in the module.

- Turning on the module with **SHAPE**, **TONE** and **SPECIAL** all held down gives **Sur** in the display (Demo mode). When the module is turned on already, press **SPECIAL** along with **LEVEL** to have **Sur** in the display; Consecutively press **DATA UP**.
- Pressing **SELECT PROG.** starts demonstration.
- Pressing **SELECT PROG.** a second time stops demonstration.
- Pressing **DATA UP** or **DOWN** selects a demo tune.
- Pressing **LEVEL** brings the module back in Single mode or the previous mode before setting the Demo mode. If you used the module in Multi mode before Demo mode entry, any setting has been lost. So, be careful.

Note: The module MIDI ports do not function in Demo mode.

■ Preset Tune List

The module comes with the following 7 preset tunes to select.

1. Nocturne
2. Le Soleil 3 (P)
3. No Faith
4. Gaia 1
5. Gaia 2
6. Prelude 'OP' 28-7
7. Ire Arabesque

Note: All demo tunes are copyrighted, so that it is prohibited to use them for any purposes except for an audition of sounds in the module.

MIDI Connections

■ Connecting to a MIDI Controller

You can control the module as a single-channel MIDI sound source controlled from a MIDI keyboard or AKAI EWI system; Put the module in Single mode by setting MULTI to OFF.

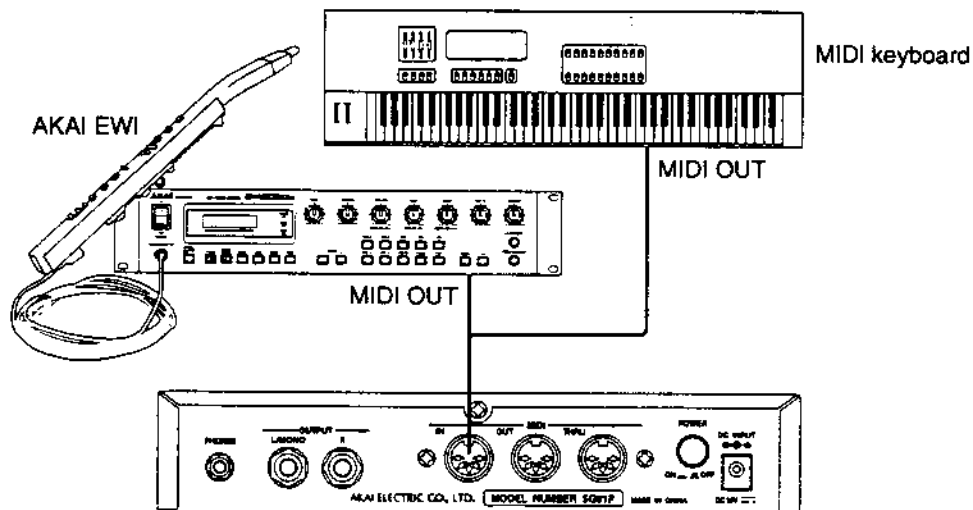

You can control the module as a multi-timbral MIDI sound source controlled from a MIDI sequencer; Put the module in Multi mode by setting MULTI to ON.

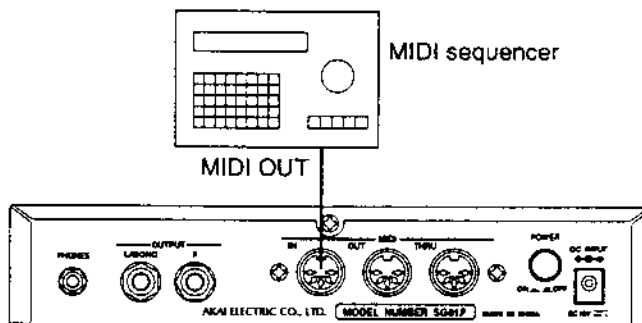

■ Using a MIDI Interface Unit

When controlling the module from a sequencing program on the computer, you need a MIDI interface unit that accepts a serial communication cable from the computer.

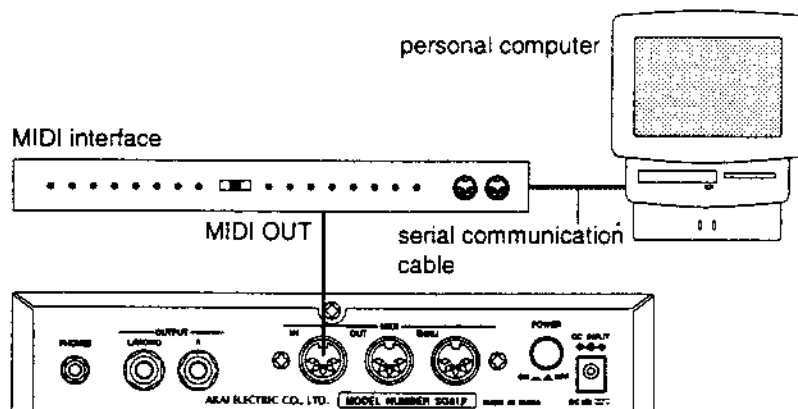

■ Connecting to a GM Sound Module

Some GM sound modules like an AKAI SG01k has a dedicated port for serial communication with a computer. You can use it as a MIDI interface unit for the module if you control it from the MIDI sequencing program running on the computer.

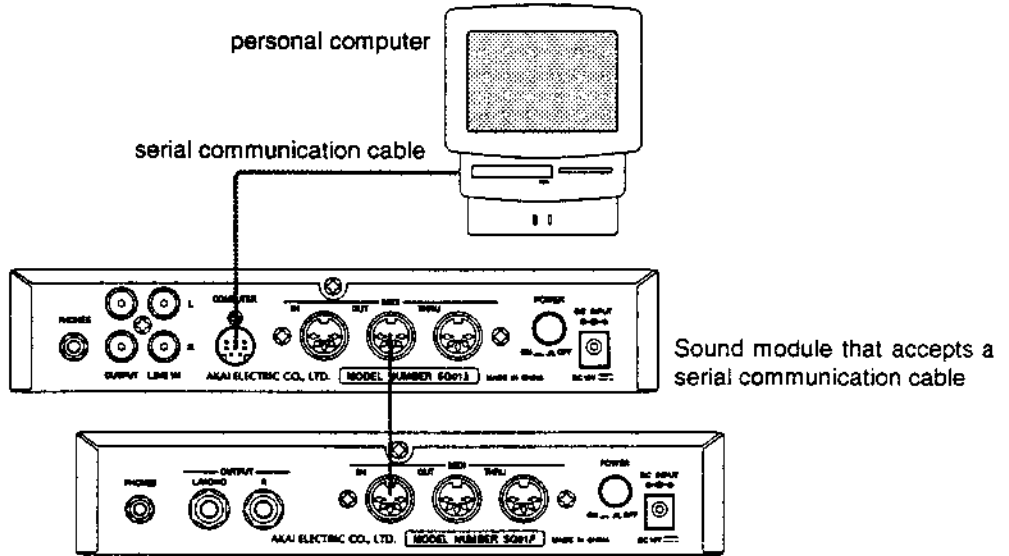

Playing

Demo Mode

The module comes with 7 preset tunes for demonstration. You do not need any MIDI controller or setup for auditioning sounds in the module.

- Turning on the module with **SHAPE**, **TONE** and **SPECIAL** all held down gives **GG 1** in the display (Demo mode). When the module is turned on already, press **SPECIAL** along with **LEVEL** to have **Sur** in the display; Consecutively press **DATA UP**.
- Pressing **SELECT PROG.** starts demonstration.
- Pressing **SELECT PROG.** a second time stops demonstration.
- Pressing **DATA UP** or **DOWN** selects a demo tune.
- Pressing **LEVEL** brings the module back in Single mode or the previous mode before setting the Demo mode. If you used the module in Multi mode before Demo mode entry, any setting has been lost. So, be careful.

Note: The module MIDI ports do not function in Demo mode.

■ Preset Tune List

The module comes with the following 7 preset tunes to select.

1. Nocturne
2. Le Soleil 3 (P)
3. No Faith
4. Gaia 1
5. Gaia 2
6. Prelude 'OP' 28-7
7. Ire Arabesque

Note: All demo tunes are copyrighted, so that it is prohibited to use them for any purposes except for an audition of sounds in the module.

Single Mode

In Single mode, you can use the module that accepts single MIDI channel signals from an external MIDI keyboard, AKAI EWI system, sequencer, etc.

1. Make connections as necessary.

Referring to the example on page 4 ~ 5, make required connections. Then turn on the equipment.

2. Put the module in Single mode.

Press **MULTI** along with **SELECT PROG.**; The **SELECT PROG.** LED blinks and **MULTI** LED is turned on. When the display shows **00**, press **DATA DOWN** to change to **0FF** to cancel Multi mode (Single mode).

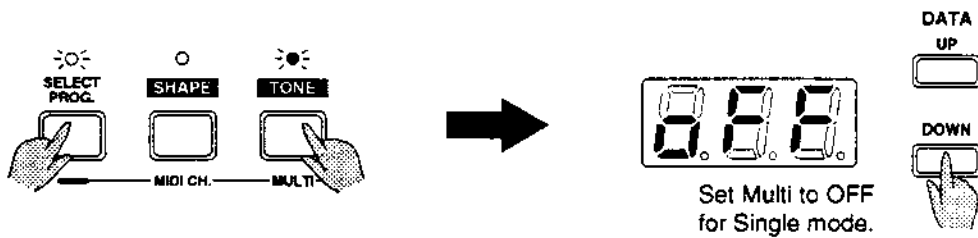

3. Set the MIDI channel.

Press **MIDI CH.** along with **SELECT PROG.**; The **SELECT PROG.** LED blinks and **MIDI** LED is turned on. Change the MIDI channel value shown in the display using **DATA UP** or **DOWN** to match that on the external MIDI controller connected to **MIDI IN**.

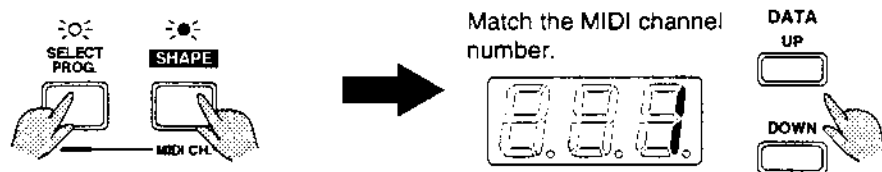

4. Select a program.

Press **SELECT PROG.**; The **SELECT PROG.** LED is turned on and other LEDs go off. Change the program value shown in the display for a desired one using **DATA UP** or **DOWN**.

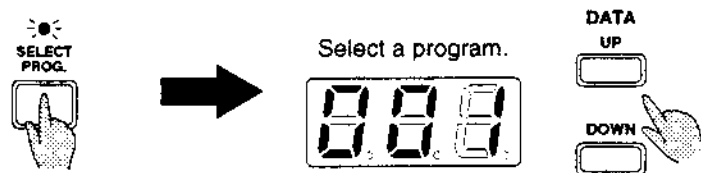

Consult the program list on page 20 if necessary.

5. Play with a current program.

Play with a current program using the MIDI controller connected. You can change programs using **DATA UP** or **DOWN** any time you like. Or, send a MIDI program change from the MIDI controller for remote program selection.

Every time the module receives an external MIDI signal, a dot in the display blinks.

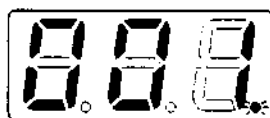

Blinking shows that MIDI signal is received.

Multi Mode

In Multi mode, the module can play a multi-part sequence data from an external MIDI sequencer or sequencing program running on the computer.

1. Make connections as necessary.

Referring to the example on page 4 – 6, make required connections. Then turn on the equipment.

2. Put the module in Multi mode.

Press **MULTI** along with **SELECT PROG.**; The **SELECT PROG.** LED blinks and **MULTI** LED is turned on. When the display shows **FF**, press **DATA UP** to change to **01** to put the module in Multi mode.

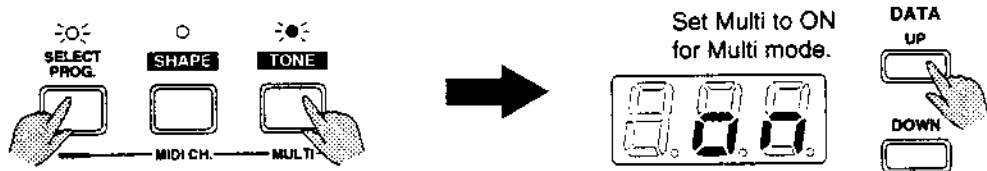

3. Assign a program to each of 16 parts.

In Multi mode, the module provides up to 16 parts for ensemble play. These 16 parts correspond respectively to 16 MIDI channels. You can choose a different program for each channel.

Press **MIDI CH.** along with **SELECT PROG.**; The **SELECT PROG.** LED blinks and **MIDI** LED is turned on; The display shows a MIDI channel value. Select a channel to assign a program using **DATA UP** or **DOWN**.

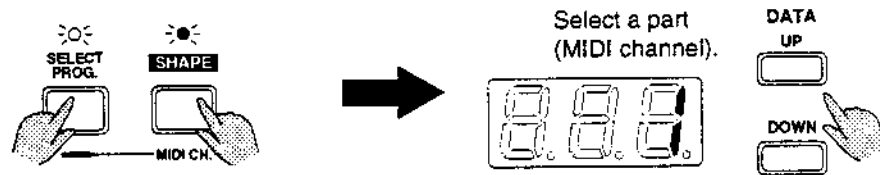

Press **SELECT PROG.** to turn on the **SELECT PROG.** LED. Select a program using **DATA UP** or **DOWN**.

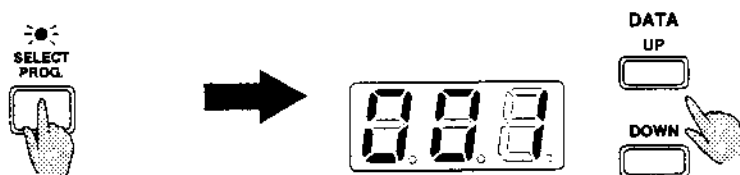

Repeat this step for other channels.

4. Start the external sequencer or sequencing program on the computer. Every time the module receives a MIDI signal, a dot in the display blinks.

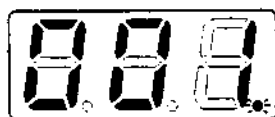

Blinking shows that MIDI signal is received.

■ Program Changes from the Sequencer

When using the module in Multi mode, it is easier to set the program selection from the sequencer or sequencer program on the computer rather than manually selecting each part.

If you program the MIDI program changes for 16 all parts at the beginning of a sequence data, the module will accept them and select specified programs every time you start that sequence.

For the actual programming, consult the manual of the sequencer in use and refer to the module MIDI implementation on page 22. In addition, MIDI program changes do not initialize the parameters, i.e. control changes including NRPN (Non-Registered Parameter Numbers).

Setups

Switching to Single/Multi Mode

The module should be put in an appropriate Play mode depending on how it is used: When you control it by a single channel using a MIDI keyboard for piano soloing, put the module in Single mode. In case controlling it by multiple channels using a MIDI sequencer, etc., put the module in Multi mode. The latter use is for a multi-part ensemble from the module.

1. Press **MULTI** along with **SELECT PROG.**: The **SELECT PROG.** LED blinks and **MULTI** LED is turned on.

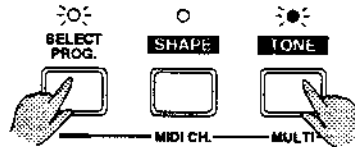

2. Switch to Single/Multi mode using **DATA UP** or **DOWN**.

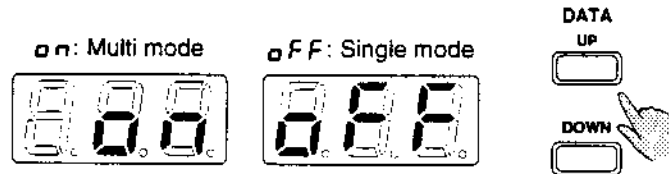

Selecting a MIDI Channel

In **Single mode**, you specify the MIDI channel for external control here.

In **Multi mode**, a MIDI channel selection matches a part selection. So, you can select a part here to assign a program or edit it after selecting the corresponding MIDI channel.

1. Press **MIDI CH.** along with **SELECT PROG.**; The **SELECT PROG.** LED blinks and **MIDI LED** is turned on.

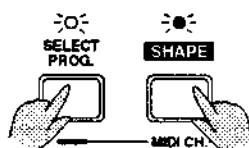

2. Select a MIDI channel using **DATA UP** or **DOWN**.

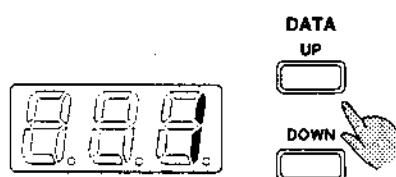

Note: Initially in **Multi mode**, a part number matches a MIDI channel number. However, if you change a MIDI channel for a part using MIDI exclusive messages, the MIDI channel displayed will not match the initial part number. For more information about this, see page 24.
In **Single mode**, the MIDI channel displayed is always the one used to receive an external MIDI signal.

Selecting a Program

A program selection in **Multi mode** requires a prior channel (part) selection. In **Single mode**, you do not care about this channel selection.

1. Pressing **SELECT PROG.** turns on the LED and the display shows a current program number.



2. Select a program using **DATA UP** or **DOWN**.



You can consult the program list on page 20.

Editing a Program

You can edit a current sound with parameters such as **SHAPE**, **TONE**, **SPECIAL**, **LEVEL** and **FX LEVEL**. In **Single mode**, you can directly edit the current sound shown in the display. In **Multi mode**, you can edit 16 different sounds respectively.

Note: A parameter value you set in **Single mode** is memorized when the module is turned off. That value is valid only in **Single mode** and does not affect the sound in **Multi mode**. So, you should edit a sound in an appropriate mode. A parameter value you set in **Multi mode** **CANNOT** be memorized and will be lost if the module is turned off or switched to **Single mode**.

Note: Available values (value range) for a parameter may vary depending on the sound selection.

◆ Key Parameter Editing System

As a general, you have to select an appropriate parameter to edit a sound program of a synthesizer or sampler, from an enormous range of sound parameters. To effectively edit a sound, you may often need certain knowledge or experience in sound creation.

For sound editing on the module, however, you do not need a special technique for sound editing because appropriate parameters for each sound are provided as 'key parameters', thus you can have them simply using the **SHAPE**, **TONE** and **SPECIAL** keys. Different key parameters are assigned to each sound. But all you need to edit a sound is always available by those three keys; **SHAPE** provides parameter options that adjust the sound envelope (attack, decay and release); **TONE** provides parameter options that adjust the sound tonal quality; **SPECIAL** provides unique parameters depending on the sound selected.

■ SHAPE—Adjusting a Sound Envelope

This parameter adjusts the sound's attack and release. It may have little effect over either attack or release depending on a sound you edit.

1. In **Single mode**, select a program you want to edit. In **Multi mode**, select a part and program you want to edit.
2. Press **SHAPE** and turn on its LED.



3. Change the value in the display using **DATA UP** or **DOWN**.



■ TONE—Adjusting a Sound Tonal Quality

This parameter adjusts the sound's tonal quality, dark to bright.

1. In Single mode, select a program you want to edit. In Multi mode, select a part and program you want to edit.
2. Press TONE and turn on its LED.



3. Change the value in the display using DATA UP or DOWN.



■ SPECIAL—Adding a Characteristic Tone

This parameter provides unique parameters depending on the sound selected. You can have suitable effects to the sound using the parameter.

1. In Single mode, select a program you want to edit. In Multi mode, select a part and program you want to edit.
2. Press SPECIAL and turn on its LED.



3. Change the value in the display using DATA UP or DOWN.

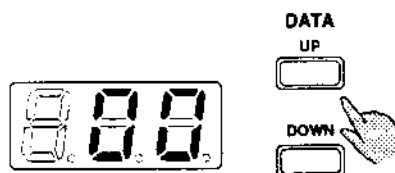

Hint: Some parameters may not give distinctive effects depending on the sound selected. Also, there are some value combinations that may affect one another (i.e. cut-off frequency and resonance). In such cases, you may need to try some value settings for a more effective result.

■ LEVEL—Adjusting a Sound Relative Level

This parameter adjusts the sound relative level because an absolute level is determined by MAIN VOLUME. That is, you can balance an output level of each sound program in Single mode whereas in Multi mode, you can balance part levels as using channel faders on a mixer.

1. In Single mode, select a program you want to edit. In Multi mode, select a part and program you want to edit.
2. Press LEVEL and turn on its LED.



3. Change the value in the display using DATA UP or DOWN. The value range is 00 to 127. The minimum value mutes the sound.

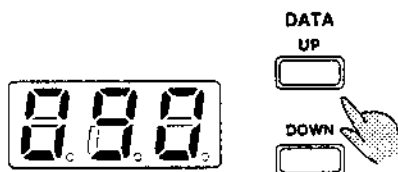

■ FX LEVEL—Adjusting a Reverb Send Level

This parameter adjusts the send level to the built-in reverb effect for the sound. That is, you can set the send level of each sound program in Single mode whereas in Multi mode, you can balance the reverb levels among parts.

1. In Single mode, select a program you want to edit. In Multi mode, select a part and program you want to edit.
2. Press FX LEVEL along with SELECT PROG.; The SELECT PROG. LED blinks and FX LEVEL LED is turned on.

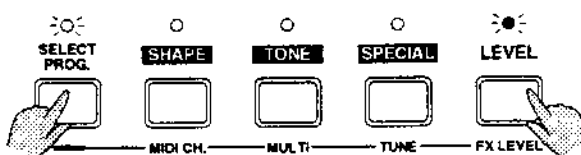

3. Change the value in the display using DATA UP or DOWN. The value range is 00 to 15. The minimum value adds no reverb effect to the sound.



Note: You can change the reverb effect type by NRPN (Non-Registered Parameter Numbers: one of MIDI control changes). See page 23 for detailed information. Also, you can turn off the reverb effect by MIDI exclusive messages (See page 24.). When you turn off the reverb, the module can play up to 32 voices (normally 30 voices with the reverb on).

■ Resetting a Program

Parameter values you edit in Single mode are memorized when the module is turned off. If necessary, you can clear them for initial settings.

1. Press **SHAPE** along with **LEVEL**.

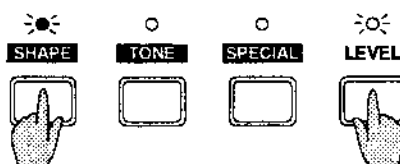

2. While **LEVEL** is held down, each pressing **SHAPE** toggles \llcorner and \lrcorner . Select \llcorner to reset only the current program or \lrcorner to reset all programs.



Resets only the current program.



Resets all programs.

3. Press **DATA UP** to execute resetting. If you cancel it, press any key other than **DATA UP**.

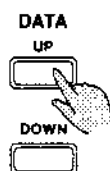

If you reset the whole parameters including those for programs to factory settings, turn on the module with **DATA UP** and **DOWN** both held down; The display shows \llcorner and all factory settings are brought again.

■ Saving Parameter Settings onto an External MIDI Device

You can transfer parameter settings you made in Single mode as exclusive bulk data, onto an external MIDI sequencer or recorder. In addition, see page 24 for details of the system exclusive messages of the module.

1. Connect the module MIDI OUT port to the MIDI device MIDI IN port using a MIDI cable.
2. On the MIDI device that records bulk data, prepare for data reception.
3. Press **TONE** along with **LEVEL**; The display shows *b d n*.

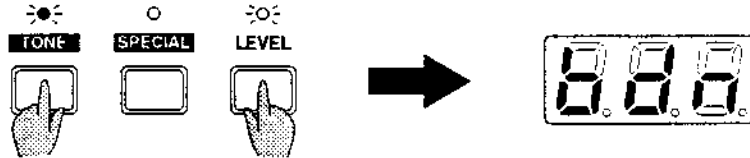

4. Press **DATA UP** to transfer bulk data.

When you transfer the bulk data from the MIDI device to the module, connect the module MIDI IN port and the MIDI device MIDI OUT port using a MIDI cable; Then prepare that data and start playback on the MIDI device.

Tuning

You can adjust the whole pitch of the module when playing it together with other instruments.

1. Press **TUNE** along with **SELECT PROG.**; The **SELECT PROG.** LED blinks and the **TUNE** LED is turned on.

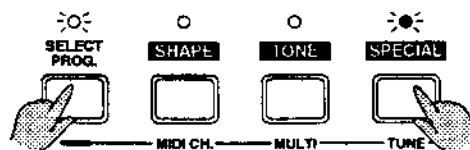

2. Adjust the pitch value in the display using **DATA UP** or **DOWN**. The value range is -50 to 0 to $+50$; You can adjust the pitch by the cent (100 cents = 1 semitone).

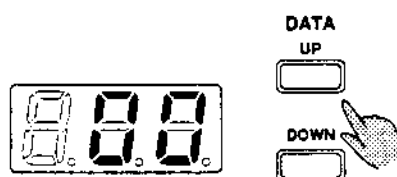

Appendix

Program List

Grand Piano		
No	Sound Name	MODE
1	RICH GRAND	ST
2	TIGHT GRAND	ST
3	BRIGHT GRAND	ST
4	LIGHT GRAND	ST
5	MELLOW GRAND	ST
6	SOFT GRAND	ST
7	HONKY GRAND	ST
8	DETUNE GRAND	ST
9	VIVID GRAND	ST
10	MILD GRAND	ST
11	RICH PIANO	MONO
12	TIGHT PIANO	MONO
13	BRIGHT PIANO	MONO
14	LIGHT PIANO	MONO
15	MELLOW PIANO	MONO
16	SOFT PIANO	MONO
17	HOLY PIANO	MONO
18	COMBO PIANO	MONO
19	CONSERT PF	MONO
20	METAL PIANO	MONO

Electric Piano		
No	Sound Name	MODE
21	SG D. PFI ST	ST
22	CRYSTAL. E. PS	ST
23	TRAD. E. PFS	ST
24	TRAD E. PF 2S	ST
25	RECENT E. PFS	ST
26	STRICT E. PFS	ST
27	BRIGHT E. PFS	ST
28	STARRY E. PFS	ST
29	GENTLE E. PFS	ST
30	CLASSIC E.PF	ST
31	SG D. PF	MONO
32	CRYSTAL. E. P	MONO
33	TRAD. E. PF	MONO
34	TRAD E. PF 2	MONO
35	RECENT E. PF	MONO
36	STRICT E. PF	MONO
37	BRIGHT E. PF	MONO
38	STARRY E. PF	MONO
39	GENTLE E. PF	MONO
40	BASIC E.PF	MONO

Clavinet		
No	Sound Name	MODE
41	CLAVINET S	ST
42	CLAVINET 2 S	ST
43	CLAVINET 3 S	ST
44	CLAVINET 6 S	ST
45	CLAVINET	MONO
46	CLAVINET 2	MONO
47	CLAVINET 3	MONO
48	CLAVINET 4	MONO
49	CLAVINET 5	MONO
50	CLAVINET 6	MONO

PC# : Program number

MODE : ST (Stereo sound) or MONO (Mono sound). ST requires 2 polyphonic voices for a single note so that it reduces a total polyphony to half (15 or 16).

■ Tonal Effects

- When Portamento Switch (on page 22) is active, sounds may not be played in a correct pitch depending on the playing style.
- When Portamento Switch (on page 22) is active, Portamento Time "0" value causes a minimum portamento time and does not turn off the portamento effect. If you turn off the effect, you need to inactivate Portamento Switch.
- Soft Pedal may have no effect over some sound programs.
- Control changes including NRPN have different effects or no effect over some sounds even when an identical value is set for the same parameter.
- A maximum or minimum setting of Pan (on page 22) does not always put the sound in the leftmost or rightmost position.

Reverb List

No.	Name	Decay	Damp	Delay	Diffuse	Hi Cut	Width
1	SG ROOM 1	0	75	0 mS	80	80	85
2	SG ROOM2	20	65	45 mS	65	80	90
3	SG ROOM 3	40	70	65 mS	75	85	95
4	SG HALL 1	75	80	80 mS	75	75	99
5	SG HALL 2	55	99	55 mS	99	95	99
6	SG PLATE 1	40	99	10 mS	99	90	99
7	TIGHT ROOM	45	60	34 mS	55	35	99
8	RICH PLATE	5	75	30 mS	99	99	99
9	SOFT PLATE	20	72	20 mS	99	15	99
10	SOFT ROOM	0	95	99 mS	99	35	95
11	FLUTTER HALL	10	29	54 mS	99	90	95
12	SMALL HALL	15	80	80 mS	75	75	99
13	BRIGHT HALL	35	90	105 mS	95	99	99
14	SOFT HALL	15	99	90 mS	75	14	99
15	WAREHOUSE 1	85	85	0 mS	99	83	99
16	SMALL HALL 2	0	99	35 mS	99	35	95
17	BRIGHT PLATE	1	99	30 mS	99	99	99
18	METAL ROOM	0	0	93 mS	32	99	99
19	SHAFT 1	31	57	360 mS	99	35	99
20	SHAFT 2	72	6	360 mS	99	35	99
21	CATHEDRAL	67	64	75 mS	15	32	99
22	TILED ROOM	67	29	67 mS	26	99	99
23	METAL SLAP	69	13	360 mS	17	99	99
24	VOCAL PLATE	50	16	10 mS	61	27	99
25	BOXED IN	52	2	86 mS	49	42	99
26	SNARE PLATE	35	22	40 mS	16	57	99
27	METAL SLAP	91	10	179 mS	46	53	99
28	NIGHT CLUB	57	99	12 mS	75	43	99
29	CORRIDOR	70	65	10 mS	55	13	99
30	AMBIENCE	56	96	10mS	56	4	20

- When the module is turned on, "#1 SG ROOM 1" is automatically chosen.
- The reverb type is possible to change using an NRPN (Non-Registered Parameter Numbers: one of control changes); See page 24 for detailed information.
Also, you can turn off the reverb effect by MIDI exclusive messages (on page 24); The module can play up to 32 voices (normally 30 voices with the reverb on) when you turn off the reverb.
- Reverb parameters cannot be edited.

MIDI Messages

■ MIDI Implementations

MIDI message descriptions in this section use following lowercase characters. Numerals are all described in hexadecimals (decimal integers in brackets).

n	: channel number	0-F (1-16 in the display)
r	: part number	0-F (1-16 in the display)
kk	: note number	00-7F (0-127)
pp	: program number	00-7F (0-127)
cc	: control number	00-7F (0-127)
vv	: 7-bit data	00-7F (0-127)
mm	: 14-bit data MSB	00-7F (0-127)
ll	: 14-bit data LSB	00-7F (0-127)
xx	: Don't care	00-7F (0-127) : dummy
ss	: check sum	00-7F (0-127)

The module receives the following MIDI messages. They may have different effects or no effect depending on the sound type. In addition, 'current notes' refers to ones that are being played out.

[Channel Voice Messages]

● Note Off

8n kk vv

A Note Off is recognized as vv=40 (64).

● Note On

9n kk vv

'vv=0' is recognized as a Note Off.

● Control Change

Bn cc vv

See "Control Change messages".

● Program Change

Cn pp

A program for pp is selected. Current notes are held in a last program.

● Channel Pressure

Dn vv

vv=00-7F (0-127)

● Pitch Bend Change

En ll mm

ll, mm=00, 00-40, 00-7F, 7F (-8192-0-+8191)

[Control Change Messages]

* Switching to Single/Multi mode resets all Control Change parameters.

● Modulation

Bn 01 vv

vv=00-7F (0-127)

Modulation depth.

● Portamento Time

Bn 05 vv

vv=00-7F (0-127)

Pitch change rate with Portamento Switch On.

● Data Entry

Bn 06 mm

mm=00-7F (0-127)

Parameter number for RPN/NRPN.

See RPN and NRPN for details.

● Volume

Bn 07 vv

vv=00-7F (0-127)

LEVEL parameter value.

● Pan

Bn 0A vv

vv=00-40-7F (0-64-127: Left-Center-Right)

A default value is 40 (64). Pan settings for rhythm notes are specified by NRPN. Some programs cannot be put in the leftmost or rightmost position.

● Expression

Bn 0B vv

vv=00-7F (0-127)

A default value is 7F (127).

● General Control #1

Bn 10 vv

vv=0E-40-72 (-50-0-+50)

SHAPE parameter value.

Some programs cannot be affected.

● General Control #2

Bn 11 vv

vv=0E-40-72 (-50-0-+50)

TONE parameter value.

Some programs cannot be affected.

● General Control #3

Bn 11 vv

vv=0E-40-72 (-50-0-+50)

SPECIAL parameter value.

Some programs cannot be affected.

● Sustain Pedal

Bn 40 vv

vv=00-3F (OFF), vv=40-7F (ON)

● Portamento Switch

Bn 41 vv

vv=00-3F (OFF), vv=40-7F (ON)

Some programs cannot be properly affected.

● Sostenuto Pedal

Bn 42 vv

vv=00-3F (OFF), vv=40-7F (ON)

● Soft Pedal

Bn 43 vv

vv=00-3F (OFF), vv=40-7F (ON)

Some programs cannot be affected.

● Effect Depth

Bn 5B vv

vv=00-7F (0-127)

FX LEVEL parameter value.

● NRPN LSB

Bn 62 ll

ll=00~7F (0~127)

LSB (Least Significant Byte) for NRPN.

See NRPN for details.

● NRPN MSB

Bn 63 mm

mm=00~7F (0~127)

MSB (Most Significant Byte) for NRPN.

See NRPN for details.

● RPN LSB

Bn 64 ll

ll=00~7F (0~127)

LSB (Least Significant Byte) for RPN.

See RPN for details.

● RPN MSB

Bn 65 mm

mm=00~7F (0~127)

MSB (Most Significant Byte) for RPN.

See RPN for details.

[Channel Mode Messages]

● All Sounds Off

Bn 78 00

Mutes all sounds currently played out.

● Reset All Controllers

Bn 79 00

Sets default values to controllers, Pitch Bend Change, Sustain Pedal, Portamento Switch, Soft Pedal, Sostenuto Pedal, Modulation, Expression, RPN and NRPN.

● All Notes Off

Bn 7B 00

Mutes sounds played by Note On messages. It does not mute sounds held by Sustain Pedal and Sostenuto Pedal; They are muted when such pedal switches turned OFF.

[RPN (Registered Parameter Numbers)]

An RPN is specified with a 14-bit data composed of MSB and LSB, followed by its 7-bit value (data MSB).

You can describe it in the order as RPN MSB, RPN LSB, Data MSB, in hexadecimal, in which the following RPNs are shown. However, you should fully describe them out with control change status messages. That is, a Pitch Bend Sensitivity value is specified as:

Bn 65 00 Bn 64 00 mm (mm: data MSB)

In addition, an RPN value is reset when you switch to Single/Multi mode.

● Pitch Bend Sensitivity

00 00 mm

mm=00~18 (0~24)

Pitch bend range for increase or decrease. (unit: semitone, up to 24 semitones)

A default value is 02 (2 semitones).

● Fine Tune

00 01 mm

mm=0E~40~72 (-50~0~+50)

Fine tuning value. (unit: cent, 100 cents=1 semitone)

● Coarse Tune

00 02 mm

mm=28~40~58 (-24~0~+24)

Coarse tuning value. (unit: semitone)

● RPN Reset

7F 7F xx

xx: No data MSB or 7-bit dummy data

Resets RPN to be unspecified. Current RPN values in the module memory are not changed.

[NRPN (Non-Registered Parameter Numbers)]

An NRPN is specified with a 14-bit data composed of MSB and LSB, followed by its 7-bit value (data MSB).

You can describe it in the order as NRPN MSB, NRPN LSB, Data MSB, in hexadecimal, in which the following NRPNs are shown. However, you should fully describe them out with control change status messages. That is, an LFO Rate Offset value is specified as:

Bn 63 01 Bn 62 08 mm (mm: data MSB)

In addition, an NRPN value is reset when you switch to Single/Multi mode.

● LFO Rate Offset

01 08 mm

mm=0E~40~72 (-50~0~+50)

LFO rate offset value added to its default rate.

● LFO Depth Offset

01 09 mm

mm=0E~40~72 (-50~0~+50)

LFO depth offset value added to its default depth.

● LFO Delay Offset

01 0A mm

mm=0E~40~72 (-50~0~+50)

LFO delay offset value added to its default delay.

● Filter Cut-off Offset

01 20 mm

mm=0E~40~72 (-50~0~+50)

Filter cut-off frequency offset value added to the default frequency.

● Filter Resonance Offset

01 21 mm

mm=0E~40~72 (-50~0~+50)

Filter resonance level offset value added to the default level.

● Envelope Attack Offset

01 63 mm

mm=0E~40~72 (-50~0~+50)

Envelope attack time offset value added to the default value.

● Envelope Decay Offset

01 64 mm

mm=0E~40~72 (-50~0~+50)

Envelope decay time offset value added to the default value.

● Envelope Release Offset

01 66 mm

mm=0E~40~72 (-50~0~+50)

Envelope release time offset value added to the default value.

● Reverb Select

00 01 mm

mm=00~1E (0~30)

Specifies the reverb type for the whole module. See page 21 for a reverb type available.

● **NRPN Reset**

7F 7F xx

xx: No data MSB or 7-bit dummy data

Resets NRPN to be unspecified. Current NRPN values in the module memory are not changed.

■ **System Exclusive Messages**

[Universal System Exclusive Messages]

● **GM System On**

F0 7E 7F 09 01 F7

Puts the module in Multi mode and initializes all performance parameters.

● **GM System Off**

F0 7E 7F 09 02 F7

Puts the module in Single mode and restores previous sound edit parameters.

[System Exclusive Messages for AKAI SG01 Series]

System Exclusive messages commonly used to AKAI SG01 series sound modules are described in the following format. All bytes are described in hexadecimal.

Byte	Explanation
F0	System Exclusive Status
47	AKAI manufacturer ID
10	Exclusive Channel (fixed)
fn	Function Code
5D	Model ID (SG01)
vv	Data
vv	Data
...	...
F7	EOX (End of Exclusive)

● **Request Bulk Dump**

Byte	Explanation
F0	System Exclusive Status
47	AKAI manufacturer ID
10	Exclusive Channel
00	Function Code=00
5D	Model ID (SG01)
bb	Bank Number (00~7F)
pp	Program Number (00~7F)
F7	EOX (End of Exclusive)

Requests the module to transmit sound parameter values (bulk data) for the program specified. The module transmits that data after receiving the Request Bulk Dump message.

● **Bulk Dump Data Set**

Byte	Explanation
F0	System Exclusive Status
47	AKAI manufacturer ID
10	Exclusive Channel
01	Function Code=01
5D	Model ID (SG01)
bb	Bank Number (00~7F)
pp	Program Number (00~7F)
vv	Data: SHAPE (0E~40~72)
vv	Data: TONE (0E~40~72)
vv	Data: SPECIAL (0E~40~72)
vv	Data: LEVEL (00~7F)
vv	Data: FX LEVEL (00~0C)
F7	EOX (End of Exclusive)

The module transmits the requested data in this format. It also accepts data in this format and replaces with the current parameter values in memory.

● **Reverb On**

F0 47 10 42 5D 40 00 06 vv F7

vv=00 (OFF), 1 (ON)

● **SG Reset**

F0 47 10 42 5D 40 00 7F 00 F7

Same operation as GM System On.

● **Master Volume**

F0 47 10 42 5D 40 00 04 vv F7

vv=00~7F (0~127)

Master volume level for the whole module.

● **Master Key Shift**

F0 47 10 42 5D 40 00 05 vv F7

vv=28~40~58 (-24~0~+24)

Master transposition value for the whole module. (unit: semitone, up to ±24 semitones)

● **Reverb Macro**

F0 47 10 42 5D 40 01 30 vv F7

vv=00~1E (0~30)

Same operation as Reverb Select of NRPN.

● **Part Reception Channel**

F0 47 10 42 5D 40 1r 02 vv F7

r=1, 2, 3... 9, 0, A, B, C... F (1~16 in the display, part number)

vv=00~0F (1~16 in the display, MIDI channel)

Specifies a MIDI reception channel (vv) for a part (r).

When vv is over 0F, that part will not receive any MIDI channel messages.

● **Part Level**

F0 47 10 42 5D 40 1r 19 vv F7

r=1, 2, 3... 9, 0, A, B, C... F (1~16 in the display, part number)

vv=00~7F (0~127)

Same operation as Volume of Control Change messages.

[System Exclusive Messages for Other Products]

The module recognizes and accepts other System Exclusive messages in the following format.

Byte	Explanation
F0	System Exclusive Status
41	Manufacturer ID
10	Device ID
42	Model ID
12	Command ID
aa	Address MSB
bb	Address LSB
cc	Data MSB
dd	Data LSB
ss	Check Sum
F7	EOX (End of Exclusive)

Check Sum is the value which makes the lower 7 bits of sum becomes "0" when Address, Data values and Check Sum are added (2's complement of a value made by adding Address value and Data value). For Reset command that follows, its Check Sum value is calculated as:

$$(80-40)+(80-00)+(80-7F)+(80-00)=41$$

So the value makes 41.

● **Reset**

F0 41 10 42 12 40 00 7F 00 41 F7
Same operation as GM System On.

● **Master Volume**

F0 41 10 42 12 40 00 04 vv ss F7
vv=00~7F (0~127)
Master volume level for the whole module.

● **Master Key Shift**

F0 41 10 42 12 40 00 05 vv ss F7
vv=28~40~58 (-24~0~+24)
Master transposition value for the whole module. (unit: semitone, up to ±24 semitones)

● **Reverb Macro**

F0 41 10 42 12 40 01 30 vv ss F7
vv=00~1E (0~30)
Same operation as Reverb Select of NRPN.

● **Part Reception Channel**

F0 41 10 42 12 40 1r 02 vv ss F7
r=1, 2, 3... 9, 0, A, B, C... F (1~16 in the display, part number)
vv=00~0F (1~16 in the display, MIDI channel)
Specifies a MIDI reception channel (vv) for a part (r).
When vv is over 0F, that part will not receive any MIDI channel messages.

● **Another Rhythm Part**

F0 41 10 42 12 40 1r 15 vv ss F7
r=1, 2, 3... 9, 0, A, B, C... F (1~16 in the display, part number)
vv=00, 01, 02
Specifies a part (r) as a rhythm part (vv).
When vv is set to 00, that part will be a normal part.

● **Part Level**

F0 41 10 42 12 40 1r 19 vv ss F7
r=1, 2, 3... 9, 0, A, B, C... F (1~16 in the display, part number)
vv=00~7F (0~127)
Same operation as Volume of Control Change messages.

SG01p MIDI Implementation Chart

Date: SEP. 1995
Version 1.00

Function ...	Transmitted	Recognized	Remarks
Basic Default Channel Changed	O 1 X	O 1 O 1-16	Memorized
Mode Default Messages Altered	X *****	Mode 3 X	
Note Number : True Voice	X *****	21-127 4-127	
Velocity Note on Note off	X X	O 9nV=1-127 O 8nV=64	
Aftertouch Key's Ch's	X X	X X	
Pitchbend	X	O	0-24 semitone steps (8-bit resolution)
Control 1 change 5 7 10 11 16 - 18 64 65 66 67	X X X X X X X X X X	O O O O O O O O O O	Modulation wheel Portament Time Volume Panpot Expression Generic Control Sustain pedal Portament Pedal Sostenuto Pedal Soft pedal
Program Change True No.	X *****	1-128	by Preset number Value
System Exclusive	O	O	AKAI ID: 47H SG01 ID: 5DH
System : Song position Common : Song select Tune	X X X	X X X	
System : Clock Real time : Commands	X X	X X	
Aux : Local ON/OFF Messages: All Notes OFF : Active Sense : Reset	X X X X	X O (123) X X	

Mode 1 : OMNI ON, POLY
Mode 3 : OMNI OFF, POLY

Mode 2 : OMNI ON, MONO
Mode 4 : OMNI OFF, MONO

O : Yes
X : No

Specifications

Model	: SG01p Piano Synthesizer Sound Module
Sound System	: 16 bit Linear Sampling
Sound Programs	: 50 Sounds
Polyphony	: 32 (30 with Reverb in use)
Sound Parameters	: SHAPE, TONE, SPECIAL, LEVEL, FX LEVEL
Panel Controls	: SELECT PROG., SHAPE, TONE, SPECIAL, LEVEL, DATA UP & DOWN, MAIN VOLUME
Connectors	: PHONES (1/8-inch stereo phone jack) 1 OUTPUT (1/4-inch phone jack) 2 MIDI IN/OUT/THRU (5-pin DIN) 3
Power Source	: 10 VDC
Accessories	: AC adapter (10 VDC converter, 800 mA) 1 Operator's Manual 1
Weight	: 1.4 kg (without attachment)
Dimensions	:

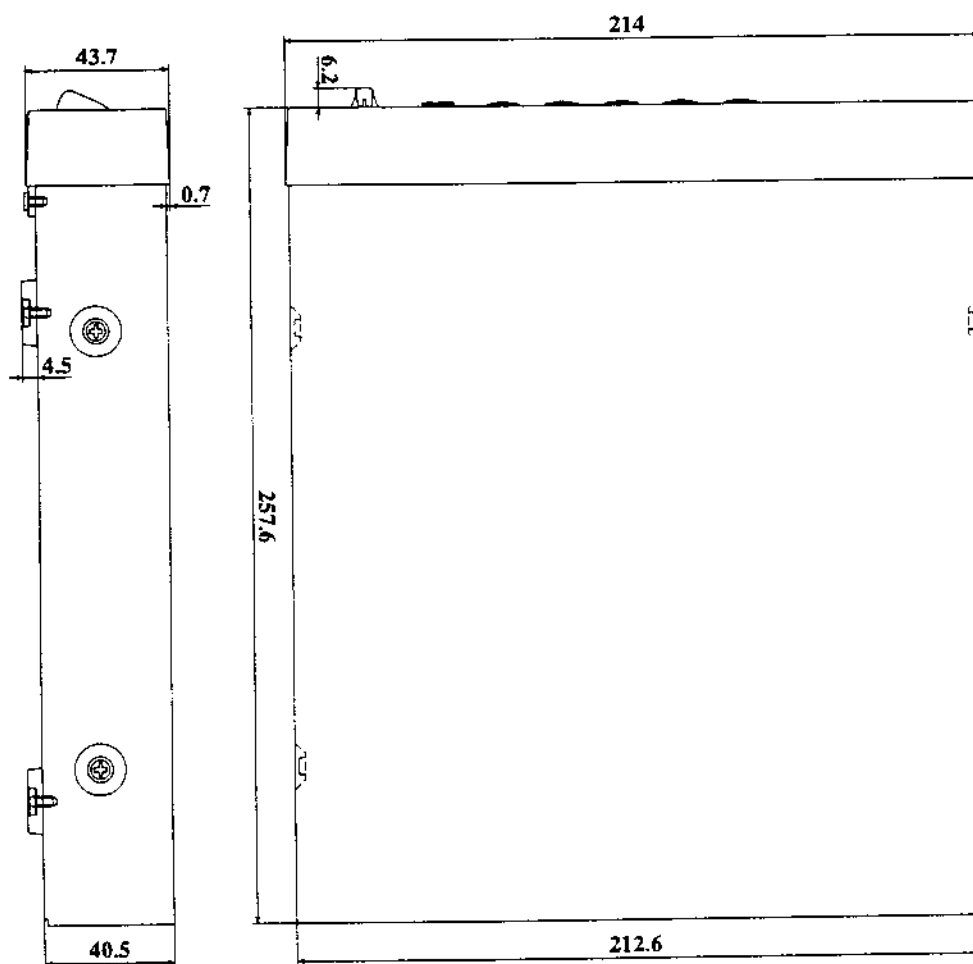

* Above specifications are subject to change without notice.

AKAI ELECTRIC CO., LTD.
Electronic Musical Instrument Div.